

Operation Manual

SHERPA

100

ECO HYPAC

NARROW



 **V2.0.1 UK**

Preface

This operating manual is for the SHERPA 100 ECO HYPAC Narrow. In order to get the most out of this SHERPA mini-loader, it is imperative that you read this manual in its entirety so you understand how the machine works and the types of work it is designed to perform.

Make sure you follow all of the manufacturer's instructions closely.

Safety should always come first when operating the machine to transport, lift and tip material. Your employees safety must never be jeopardized. Reliability and high performance are also important.

Our new, multifunctional mini skid-steer is all of these things: powerful, safe and reliable. The mini skid-steer is a compact earth-moving machine and a mobile hydraulic powerhouse.

The use of hydraulics for locomotion, lifting and many other functions makes this a very versatile and manoeuvrable machine that is easy to use and maintain. This little machine moves much more material than its size suggests.

The hydraulic drive systems are powered through a gear pump that transfers the oil to the machine's various functions through a 5-fold hydraulic control unit.

Hydraulic wheel motors in each of the rear wheels, and a chain connection to the front wheel provide the effective 4-wheel drive. This configuration makes the mini-skid steer so manoeuvrable that it can turn on its own axis.

A quick-connect system enables the mini skid-steer to be quickly fit with a wide range of attachment tools, each of which is specially developed and built. Quick-couplings are used to connect servo tools to the external function.

SHERPA mini-loaders wishes you ease of use of our mini skid-steer loader.



....Made in Holland

Copyright © 2013-2019 SHERPA mini-loaders.
All rights reserved.

The machine can be subject to change in relation to new technical developments.
Therefore no claims can be derived from this operating instructions.

Any form of reproduction, reprinting or unauthorized use without the written permission of SHERPA mini-loaders is strictly prohibited.

Contents

Preface	1
Introduction.....	6
1. Description of the mini skid-steer	7
1.1. Operation.....	7
1.1.1. <i>Design.....</i>	7
1.1.2. <i>Drive system</i>	7
1.2. Technical data and tipping loads.....	8
1.2.1. <i>Technical data.....</i>	8
1.2.2. <i>Tipping loads.....</i>	9
1.3. Operating and control area	10
1.4. Explanation of the identification signs.....	11
1.4.1. <i>Manufacturer's plate</i>	11
1.4.2. <i>CE-mark.....</i>	11
1.4.3. <i>Storage container for the user manual</i>	11
2. Purpose.....	12
2.1. Intended use.....	12
2.1.1. <i>Types of work.....</i>	12
2.1.2. <i>Load</i>	12
2.1.3. <i>Ambient temperature</i>	12
2.1.4. <i>Public roads</i>	12
2.2. Tools or equipment.....	13
2.3. Other use.....	13
3. Safety and warnings	14
3.1. General	14
3.2. Basic safety definitions.....	15
3.2.1. <i>Organizational measures.....</i>	15
3.2.2. <i>Safety regulations for the operator</i>	16
3.2.3. <i>Safety during use.....</i>	19
3.2.4. <i>Fuel and lubricant safety.....</i>	19
3.2.5. <i>Safety concerning the traction battery</i>	20
3.2.6. <i>Safety regarding the charging/use of the traction battery.....</i>	22
3.2.7. <i>Hydraulic drive system safety.....</i>	22
3.2.8. <i>Transporting, hoisting and lifting safety</i>	23
3.3. Guarantee.....	24
3.3.1. <i>Guarantee clause</i>	24
3.3.2. <i>Warranty determination traction battery</i>	24

3.4. Machine pictograms	25
3.4.1. Mini-loader	25
3.4.2. Traction battery	29
4. Operation	30
4.1. Control elements	30
4.1.1. Drive controls	30
4.1.2. Braking	32
4.1.3. Lifting control	32
4.1.4. Tilting control	32
4.1.5. Auxiliary lever	33
4.2. Operating the engine	34
4.2.1. Starting the engine	34
4.2.2. Stopping the engine	34
4.3. Loading and unloading	35
4.4. Attaching and detaching attachment tools	37
4.4.1. Requirements for attachment tools	37
4.4.2. Mounting plate	37
4.4.3. Attaching tools	37
4.4.4. Detaching tools	38
4.4.5. Auxiliary system	38
5. Use of the traction battery	39
5.1. General	39
5.2. Charging Traction battery	40
5.2.1. Installing the charger	40
5.2.2. Connection sequence	40
5.3. Refilling	42
5.3.1. Installation mini-loader	42
5.4. Changing Traction battery	44
6. Maintenance	46
6.1. General	46
6.1.1. Locking the lift arm	46
6.1.2. Hour counter & battery level indicator	47
6.2. Maintenance schedule for traction batteries	48
6.3. Daily	49
6.3.1. Charging	49
6.3.2. Refilling distilled water	49
6.4. Half-yearly	50
6.4.1. Check specific gravity and temperature	50

6.5. Yearly.....	51
6.5.1. <i>Check isolation resistance</i>	<i>51</i>
6.6. Maintenance schedule for the mini skid-steer.....	52
6.7. Every 10 operating hours or daily	53
6.7.1. <i>General</i>	<i>53</i>
6.7.2. <i>Check for leaks in the hydraulic drive systems.....</i>	<i>53</i>
6.7.3. <i>Check the hydraulic oil level</i>	<i>54</i>
6.8. Every 50 operating hours or monthly.....	55
6.8.1. <i>General</i>	<i>55</i>
6.8.2. <i>Check wheel nuts</i>	<i>55</i>
6.8.3. <i>Check tire pressure.....</i>	<i>56</i>
6.9. Every 200 operating hours or half-yearly.....	57
6.9.1. <i>General</i>	<i>57</i>
6.9.2. <i>Change the hydraulic oil filter</i>	<i>57</i>
6.9.3. <i>Check all fasteners</i>	<i>57</i>
6.9.4. <i>Check/adjust chain tension.....</i>	<i>58</i>
6.9.5. <i>Check/replace pins and bearing bushes</i>	<i>59</i>
6.10. Every 600 operating hours or yearly.....	60
6.10.1. <i>Change the wheels</i>	<i>60</i>
6.11. Every 1000 operating hours	61
6.11.1. <i>Change hydraulic oil</i>	<i>61</i>
7. Transport and storage	62
7.1. Transport.....	62
7.1.1. <i>Transportation on a trailer.....</i>	<i>62</i>
7.1.2. <i>Towing</i>	<i>62</i>
7.1.3. <i>Lifting</i>	<i>63</i>
7.2. Storage	64
7.2.1. <i>Preparing the machine for storage</i>	<i>64</i>
7.2.2. <i>Preparing the machine for use.....</i>	<i>64</i>
8. Driving on hilly terrain and slopes.....	65
9. Failures	66
9.1. <i>Melting fuse table</i>	<i>66</i>
10. Appendices.....	67
10.1. <i>Hydraulics diagram</i>	<i>67</i>
10.2. <i>Electrical circuit diagrams</i>	<i>67</i>
10.3. <i>User manual charger.....</i>	<i>67</i>
10.4. <i>Operation & maintenance instructions for traction batteries.....</i>	<i>67</i>
10.5. <i>Attachment tools & accessories</i>	<i>67</i>

Introduction

This operating manual is for the SHERPA 100 ECO HYPAC Narrow, which is manufactured by SHERPA mini-loaders in Nistelrode, the Netherlands.

This manual contains everything you need to know about the operation, maintenance and safe use of the machine. Dangerous situations are pointed out and warnings issued against unsafe use, working in unsafe conditions and using the machine for purposes other than those intended by the manufacturer. In short, this manual explains the safe use of the machine so you get the most out of it.

This manual is an integral part of the machine and must be kept with the machine at all times.

Ignoring safety rules or any of the other instructions in this operating manual will be considered as negligent conduct.

The mini skid-steer is a machine that comes with risks. Although SHERPA mini-loaders have paid the utmost attention to designing and building a safe machine, it is impossible to build a machine like this that is free from risk for the operator and the immediate work environment. The risks arise mainly from the lift arms and the machine's mobility.

This means that the operator has a lot of responsibility for his/her own safety and that of his/her immediate surroundings.

The following warning symbols are used to draw your attention to specific safety aspects and issues. Please heed them.



Danger!

Draws the operator's attention to potential issues or safety rules.



Attention!

Indicates the risks that can arise when working with or on the mini skid-steer.



Attention!

The operating manual must be kept with the machine at all times. The machine is fit with a plastic container. Store the manual in the container in its plastic sleeve to prevent it from getting wet. This container also stores the tools used to lock the lift arm during maintenance and repair work.

This operating manual has been compiled with the utmost care. If you have questions about or problems with the operation or the maintenance of the mini skid-steer, please contact SHERPA mini-loaders as quickly as possible.

Address: see the first page of this manual.

1. Description of the mini skid-steer

1.1. Operation

1.1.1. Design

The mini skid-steer consists of a single frame. The frame has lift arms to which tools and implements can be attached. Examples of such tools and implements are a bucket, fork or broom. Other tools and implements are available. See Attachment: "Tools and accessories".



Attention!

The machine is delivered without attachment tools.

The front of the machine is fitted with a hydraulic coupling to connect power tools. The connection consists of a dual coupling so the hydraulic fluid can flow in two directions.

Removing the bonnet/cover plate at the front of the machine provides access to the engine compartment. This is where the engine and the battery are stored.



Attention!

Make sure the lift arm is locked during maintenance/repair work. See section 6.1.1. (Locking the lift arm).

1.1.2. Drive system

The lifting, tipping and auxiliary systems, and the wheels, are powered by a electric motor to which the oil pump is connected.

The electric motor comes into force as soon as your feet stand on the platform and the foot switch plate is pressed. The engine stops when you step off the platform (reckon with a starting delay of the electric motor of two seconds).

The hydraulic drive system for the machine consists of two hydraulic motors that are mounted on the rear wheels. The front wheel is driven by a chain that is connected to the rear wheel.



The machine is set in motion by operating the two red levers. Operate the levers calmly and cautiously.

Operating the left lever turns the left wheels.

Operating the right lever turns the right wheels.

Operating both levers in the same direction moves the mini skid-steer straight ahead.

Operating each lever in a different direction moves the mini skid-steer in a specific direction.

1.2. Technical data and tipping loads

1.2.1. Technical data

Engine:

Manufacturer:	Sevcon
Type:	HypAC
Capacity (kW/pk):	1.5/2
Max. speed (rpm):	1800
Tuned speed (rpm):	1800
System:	Brushless DC motor
Coolant:	Air cooled

Drive system:

Hydrostatic through 2 hydraulic wheelmotors/
2 front wheels through chain transmission

Speed (km/h): 0-3.5 (proportional)

Capacity data:

Breakout force (kg):	497
Tractive force (kg):	250
Hydraulic drive system (l/bar):	14.4/150
Hydraulic tank capacity (l):	38

Tires: 4.00x10

Brakes:

Service break: Hydrostatic on 2 rear wheels/
2 front wheels through chain transmission

Steering:

Type: Skid steering

Electrical system:

Voltage (V $\overline{---}$):	24
Battery capacity (Ah):	360 (traction battery)

Dimensions (L_{mm} x W_{mm} x H_{mm}): 1490 x 760 x 1218 (without attachment tools)

Kerb weight (kg): 759

1.2.2. Tipping loads

The tipping loads are specified in the below table for each type of bucket and fork. The loads are based on standard LCD sizes in accordance with NEN-EN 474-3.

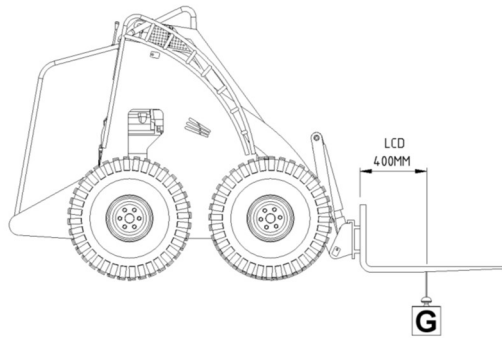

Explanation:

LCD Distance from the load's center of gravity to the tool's mounting point (mounting plate). Unit of measure: MM

G Weight of the load Unit of measure: KG

Nominal working loads:

The nominal working loads on a solid level surface with the correct tire pressure **and operator (60 kg).**

In other conditions such as rough terrain, slopes and so forth, a lower working load applies.

Tipping load [kg] *

Pallet forks load low **

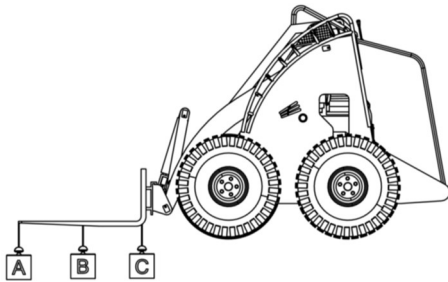

A 279

B 407

C 743

Pallet forks load high **

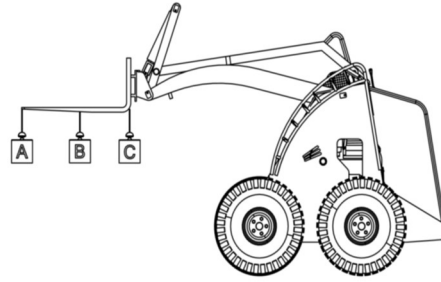

A 193

B 264

C 410

*60kg operator included

**Taking into account a safety factor of 30%

1.3. Operating and control area

The operating location of the mini-skid steer loader is behind the platform.



1.4. Explanation of the identification signs

1.4.1. Manufacturer's plate



<i>Explanation of the information on the manufacturer's plate</i>	
<i>Manufacturer</i>	<i>Name and address of manufacturer</i>
<i>Type</i>	<i>The type number or description</i>
<i>Serial no.</i>	<i>Serial number</i>
<i>Weight</i>	<i>Weight [kg]</i>
<i>Year</i>	<i>Year of manufacture</i>
<i>Power</i>	<i>Capacity [kW]</i>

1.4.2. CE-mark

The CE-mark on the manufacturer's plate indicates that the mini skid-steer conforms with the applicable European directives.

1.4.3. Storage container for the user manual

The operating manual must be kept with the machine at all times.

There is a plastic container to store the manual on the side of the frame. Store the manual in the container in its plastic sleeve to prevent it from getting wet, which would make the manual hard to read.

This container also stores the tools used to lock the lift arm during maintenance and repair work.



2. Purpose

2.1. Intended use

2.1.1. Types of work

The mini skid-steer can be used to perform the following types of work:

- Moving, “lifting” and “tipping” of sand, earth, gravel or other loose material.
- Moving rocks.
- Moving full pallets.
- Moving, “lifting” and “tipping” other material.
- Moving and powering attachment tools.

2.1.2. Load

The maximum load may not be exceeded for any of the above-mentioned types of work. The allowable load is indicated in section 1.2.2. (Tipping loads).

2.1.3. Ambient temperature

The ambient temperature must be between -20°C and +30°C. Using the machine outside this temperature range can be dangerous and is therefore prohibited.

Contact the manufacturer if you would like to use the machine in a temperature outside of this range.

2.1.4. Public roads

The mini skid-steer does not meet road traffic regulations and may therefore not be driven on public roads.

2.2. Tools or equipment

A shovel, fork or other attachment tool that is mounted on the mini skid-steer must not exceed the volume and load capacity of the mini skid-steer stated in section 1.2.2. (Tipping loads), and it has to be announced in the enclosure: "Attachments & options".

It is permitted to use hydraulic tools providing the total hydraulic working load is lower or equal to the maximum allowable hydraulic load.

It must also meet the requirements of the European Machine Directive 2006/42/EG.

2.3. Other use

Using the mini skid-steer for purposes other than those described above can affect the safety of the operator and/or bystanders and is therefore prohibited.

3. Safety and warnings

3.1. General

The mini skid-steer is designed in accordance with the requirements of the European safety directives laid out by the European Commission in the European Machine Directive.

The mini skid-steer is designed to prevent unsafe situations as much as possible. Protective measures have been taken for unsafe situations that could not be prevented by design or construction. For situations for which protective measures could not be taken, pictograms and text are used to draw the operator's attention to the risks.



Danger!

Guards

The guards that are mounted on the mini skid-steer may not be removed.



Danger!

Changes/adaptations

Changes and adaptations to the function, operation or principle of the mini skid-steer may not be made without permission from SHERPA mini-loaders and are the full responsibility of the person who makes them. This also applies to the safety features and the hydraulic components used in the machine.



Attention!

National and local safety regulations and rules

In addition to the safety rules discussed in this manual, the operator must also observe the safety regulations of the country in which the machine is used.

The safety rules that apply at the location at which the mini skid-steer is used must always be observed. For example, when transporting dangerous goods or working alongside the road. It is prohibited to drive the mini skid-steer on public roads.



Danger!

Operation

The people who will be operating the mini skid-steer must first read the manual and in particular section 3. (Safety and warnings).

The minimum driving age for the mini skid-steer is 18. The operator must also have sufficient expertise to operate the mini skid-steer.

It is advisable to regularly test the people who will be operating the mini skid-steer on the safe operation of the machine.

When operating the machine in closed spaces, the operator must ensure the space is sufficiently ventilated in accordance with the applicable regulations.



Danger!

Noise

The mini-skid steer produces at higher speeds (approx. 1800rpm) a noise level lower than the limit of 80 d(B)A. Therefore it is not required for the driver to wear hearing protection.



Danger!

Attachment tools

Only attachment tools with a CE-mark may be mounted on the mini skid-steer. The use of attachment tools with an allowable load or capacity that exceeds that of the mini skid-steer is prohibited.

3.2. Basic safety definitions

3.2.1. Organizational measures



Attention!

Operating manual

The manual for the mini skid-steer must be on the mini skid-steer at all times and must always be within the operator's reach.



Attention!

Pictograms

You must observe the warnings and instructions that are indicated by the pictograms on the mini skid-steer.

All warning and instruction stickers must be in a condition that enables them to be read and understood. See also section 3.4. (Machine pictograms). The warning and instruction stickers may not be removed. Damaged stickers must be replaced.



Danger!

Maintenance work

Spare parts must meet the same specifications as the original parts used by the manufacturer. Original parts guarantee safety.

Hydraulic hoses must be replaced if wear and tear or damage is detected during periodic maintenance.

The prescribed inspection and maintenance windows described in the manual must be strictly observed.

If the mini skid-steer is in need of repair or maintenance, the key must be removed from the ignition or the negative pole removed from the battery.

Maintenance and repair work on the mini skid-steer must be carried out in a well-equipped workshop.

Work on the electrical system may only be carried out by trained staff.

A blown fuse may only be replaced with a fuse with the same maximum allowable current intensity and properties.

Work on the brakes, wheels and steering mechanism may only be carried out by skilled and trained staff.

Work on the wheel motors and the hydraulic drive systems may only be carried out by specially trained staff.

You must inspect the mini skid-steer for visible signs of wear and tear and damage at least once a day.

The mini skid-steer must be cleaned regularly so the operator can work as safely as possible. During cleaning, all openings must be closed to keep out water or steam from a high-pressure cleaner.

The electric motor has an IP54 rating (Dust protection/splash proof).



Danger!

Leaving the mini skid-steer

When you leave the mini skid-steer, you must remove the key from the ignition and lower the attachment tools to the ground (rest position).

(The machine may not be parked on a slope!) This ensures the machine does not unexpectedly roll away or is used without authorization. A mini skid-steer that rolls away or is used without authorization can be a danger to the operator and/or bystanders.



Work lights

A machine that is not equipped with work lights may not be used in the dark.



Public roads

The mini skid-steer does not meet road traffic regulations and may therefore not be driven on public roads.



Ambient temperature

The ambient temperature must be between -20°C and +30°C. Using the machine outside this temperature range can be dangerous and is therefore prohibited. Contact the manufacturer if you would like to use the machine in a temperature outside of this range.

3.2.2. Safety regulations for the operator



Dangers while driving the mini skid-steer

Before you start driving/working with the mini skid-steer you must ensure that the mini skid-steer cannot hit or injure anyone.

The safety of the operator must never be jeopardized.

The safety of the operator can be jeopardized if:

- *the machine is being driven or loaded on uneven terrain. See section 8. (Driving on hilly terrain and slopes).*
- *a turn is taken at high speed (loss of stability).*
- *the total allowable weight is exceeded (loss of stability).*

The following general rules apply to the mini skid-steer:

- *Drive with the load as close to the ground as possible.*

Stop the mini skid-steer in the event of a calamity.



Driving with the mini skid-steer

Check the proper functioning of the mini skid-steer every day.

You must raise material and drive the mini skid-steer as steadily as possible to guarantee the machine remains stable.

Never drive the mini skid-steer too close to a trench or pit. If the surface is not sufficiently sturdy, the machine can topple over.

Do not drive the mini skid-steer in closed spaces. There is a risk of asphyxiation.

Never take passengers on board; neither at the front nor at the back!

The attachment tools must be lowered to the ground when the mini skid-steer is not in use. When you are finished using the mini skid-steer, park it on a level sturdy surface and remove the key from the ignition.



Capacity

Observe the allowable machine capacity, see section 1.2.2. (Tipping loads).

Overloading the machine can have serious implications, such as the machine toppling over.

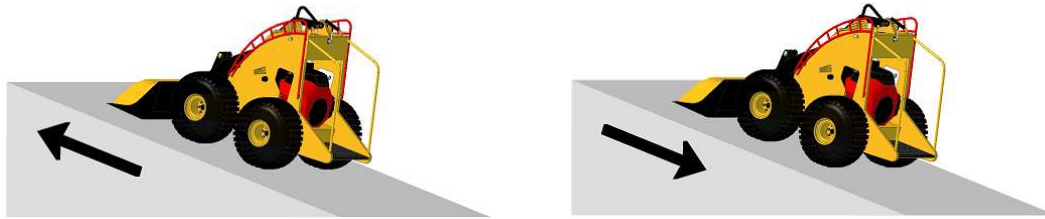

(driving with load)

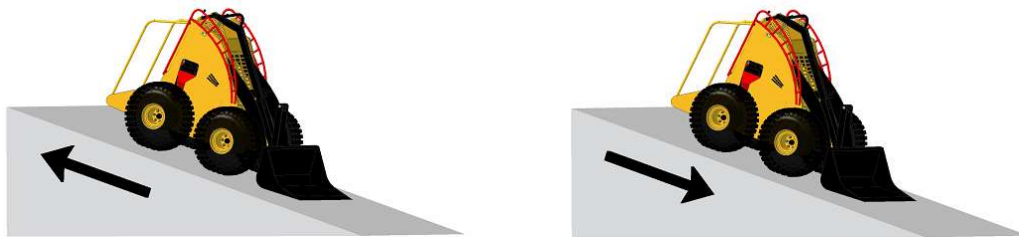

(driving without load)



Danger!

Driving with load

When driving with a raised load, the speed must be as low as possible to minimize the risk of toppling over.

Always drive with the load's center of gravity as low as possible. This reduces the risk of toppling over.

When driving up or down a hill with a load, you must drive backwards or forwards, depending on the load (see above examples).



Danger!

Driving without attachments

The driver should be aware of the risk of tipping over when no attachments are mounted on the machine.



Attention!

First come to a stop before switching from backward driving to forward driving.



Danger!

Bystanders

Bystanders are not allowed to linger around the mini skid-steer.



It is prohibited to transport people on the mini skid-steer

The operator of the mini skid-steer may not, under any circumstances, transport people at the front or the back of the mini skid-steer.



It is prohibited to lift people with the mini skid-steer

The operator of the mini skid-steer may not, under any circumstances, lift people with or without the attachment tools or other equipment.

Additional requirements for use

The mini skid-steer may only be operated from the platform at the back of the machine. Before you leave the platform, the load or the attachment tool must be in the lowest position.

When the operator leaves the mini skid-steer (meaning walks away) the engine must be switched off and the key removed from the ignition.

When operating the mini skid-steer, the operator must pay attention to his/her safety and that of his/her surroundings.

If a problem arises with the mini skid-steer, switch off the engine immediately and observe all of the associated rules.

If a problem arises at the mini skid-steer's place of work, all work must cease immediately. In weather conditions that can present a hazard (heavy fog, thunderstorms) you must park the machine in a safe place and leave it.

Do not do any work with the mini skid-steer that is unsafe.

Before each use, the operator must familiarize himself/herself with the safety, terrain and driving conditions at the place of work.

When using the mini skid-steer indoors, the operator must ensure the space is sufficiently ventilated.



Clothing and personal protective equipment

People working with the mini skid-steer may not wear loose-fitting clothes or dangling jewelry and long hair must be tied back and/or covered. Such items present a risk of injury through entanglement.

The people operating the mini skid-steer must wear the mandatory or required personal protective equipment.

Problems during use

If a problem arises with the mini skid-steer, switch off the engine immediately and observe all of the associated rules.

If a problem arises at the mini skid-steer's place of work, all work must cease immediately.



3.2.3. Safety during use



Starting the mini skid-steer

The engine may not be started until the operator has checked that the mini skid-steer will not move when started.

To avoid operating errors, the operator must familiarize himself/herself with the way the mini skid-steer works.

When you start the mini skid-steer, make sure no one is standing near the mini skid-steer and could be harmed when the machine is started.

Before using the mini skid-steer, check the brakes, steering mechanism, work lights and signal indicators for visual damage.

Before the machine is started, the oil lines and couplings must be checked for wear and tear and damage to prevent oil leaking.

3.2.4. Fuel and lubricant safety



Environment

Environmentally harmful substances (e.g. liquids and lubricants) must be stored and disposed of in accordance with the applicable regulations.



Smoking and naked flames are prohibited when working with flammable substances.



Clean up spilt fuel or lubricant immediately. They are harmful to the environment and are a fire and explosion hazard.



Electrolyte contains sulphuric acid [H₂SO₄] and is extremely corrosive. Acid splashes in eyes or on skin first should be rinsed with plenty of water. Then immediately consult a doctor. Clothing that came in contact with acid should be washed.



Worn traction batteries can be reused and recycled. Batteries should be removed according to the applicable regulations for chemical waste. Please contact the manufacturer.

3.2.5. Safety concerning the traction battery



Attention!

Before servicing the traction battery carefully read the manual of the manufacturer of the battery.



Danger!

Carry out maintenance (filling, charging, etc.) always with the engine switched off. The ignition key should be removed and the traction battery should be disconnected.



Danger!

Only service the battery under the supervision of trained personnel. Always wear safety goggles and protective clothing when servicing the battery. Comply with the safety rules according to the regulations Standard DIN VDE 0510, VDE 0105 T1 V.



Attention!

Don't tilt the battery. Only use approved lifting or hoisting equipment. Lifting hooks may not cause any damage to cells, connections or cables.



Danger!

For explosion-proof batteries [Ex1 and ex2] please make sure that the associated guidelines are followed to ensure explosion protection.



Danger!

Battery hazards

It is prohibited to work on the battery.

Keep sparks, flames and flammable substances away from the battery.

- *Wear safety glasses.*
- *Make sure the mini skid-steer is electrically isolated.*
- *Make sure the battery is not frozen.*

If you unfortunately come in contact with electrolyte please follow the instructions below.



Attention!

First aid for accidents with battery fluid

- **If inhaled:** Remove victim to fresh air. Keep victim at rest in a position comfortable for breathing. If necessary, administer oxygen and take the victim to hospital immediately.
- **If in eyes:** Rinse cautiously with water for several minutes. Remove contact lenses if present and easy to do. Continue rinsing. Do not use any neutralizing substances and contact a doctor immediately.
- **If on skin:** Remove/take off all contaminated clothing immediately. Rinse skin with water/shower. Contact a doctor immediately in the case of burns.
- **If swallowed:** Rinse mouth immediately and drink water as a precautionary measure. Do not induce vomiting and take the victim to hospital immediately.



Danger!

Hydrogen gas (oxyhydrogen) is harmful. Provide adequate ventilation when the machine is used in confined spaces. avoid breathing in the gases as much as possible.



Attention!

Replacing the battery

Only install a battery with the same properties as the original battery.

3.2.6. Safety regarding the charging/use of the traction battery



Before you use the machine carefully read the safety data sheets from the manufacturer of the battery and the charger.



Explosion hazard

During and shortly after charging the battery electrolytic gas comes free, an extremely explosive gas mix. In no circumstances it is allowed to use open flames or glowing parts in the vicinity of the cells. Don't place any metal parts on the battery. To prevent sparks don't disconnect any power wires during charging.



The traction battery is supplied with a hydrogen (electrolytic gas) venting system. The vent hose is located on the right side of the machine. Never close this opening!



If the connection of the air line (vent hose) is led outside separately, first the air connection and then the charging plug should be connected.



The charger should not be placed near any heat emitters. The openings in the casing care for better heat discharge of the components and may not be covered. Position the charger in a dry area that is adequately ventilated. Comply with the regulation Standard DIN VDE510 Part 1. The charger must be protected against moisture, may only be used in dry rooms and should only be opened by trained personnel. Before opening the power plug should be disconnected.

3.2.7. Hydraulic drive system safety



- *Hydraulic hoses must be replaced if wear and tear or damage is detected during periodic maintenance.*
- *When working on the hydraulic drive system, make sure the system is not under pressure.*
- *Work on the wheel motors and the hydraulic drive system may only be carried out by specially trained staff.*



Work may only be carried out with the engine switched off. Work on the hydraulic drive system may only be carried out when the system is not under pressure. All hydraulic cylinders must be in their rest position.



Danger!

- *Never try to repair or seal hydraulic hoses or couplings while the machine is running or when the hydraulic drive system is under pressure. The liquid has such a high pressure that the hydraulic oil can easily penetrate the skin and cause serious injuries.*
- *Wait until the hydraulic oil has cooled down. Hot hydraulic oil can cause serious burns.*
- *Never use your hands to check the hydraulic drive system for leaks. Hydraulic oil can cause serious injury if it penetrates the human body.*
- *Always wear safety gloves and the appropriate eye protection when working on the hydraulic drive system.*

3.2.8. Transporting, hoisting and lifting safety



Attention!

*The mini skid-steer may **not** be towed.*



Attention!

The kerb weight of the machine is 759kg without attachments and standard tires.

3.3. Guarantee

The guarantee period is confirmed on the order confirmation.

3.3.1. Guarantee clause

The guarantee lapses if:

- repairs, replacements or extensions on or to the machine and/or accessories were carried out by yourself or a third party;
- SHERPA mini-loaders. believes that the machine and/or accessories have been neglected or carelessly and unprofessionally used, treated and/or maintained, and/or there is evidence of abnormal wear and tear;
- type numbers and/or serial numbers have been damaged, removed and/or changed;
- damage was caused by falling, banging or other external influences, including sand and condensation;
- changes were made to the purchase invoice.

3.3.2. Warranty determination traction battery











If the instructions are not followed, for example repairs with non-original parts, by incompetent staff, or when the electrolyte is filled with liquids or other additives than water that is suitable for this battery, the warranty on the battery and all liability is excluded.

Regularly overloading or to deep discharging expires the warranty of the machine immediately.

3.4. Machine pictograms

3.4.1. Mini-loader

The following pictograms can be found on the mini skid-steer: These pictograms draw the operator's attention to the potential risks and hazards associated with using the mini skid-steer. The pictograms may not be removed. Pictograms that are damaged or have become unreadable must be replaced.

Pictogram	Explanation	Place on mini-loader
	<i>Danger of entrapment</i>	
	<i>Prohibited to linger in the work area</i>	
	<i>Do not carry passengers</i>	
	<i>Lock attachment tools during use</i>	
	<i>Do not drive with raised load</i>	
	<i>Fastening point for lifting hook</i>	



Warning!! Read the manual before proceeding

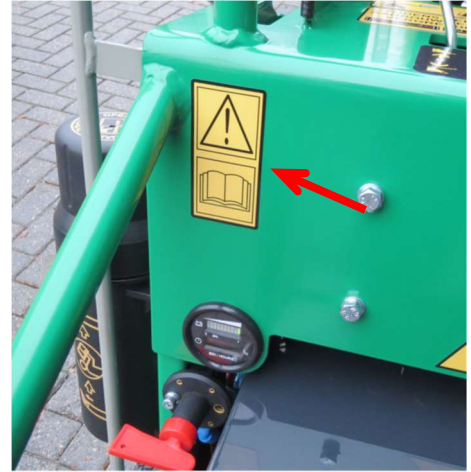

Risk of tipping, When driving without load



Check wheelnuts



The electric motor has an IP class 54 (splash waterproof)

Do not spray on the electrical parts with a high pressure cleaner





Various warnings for which no icon is present on the machine

(Text according as below)*

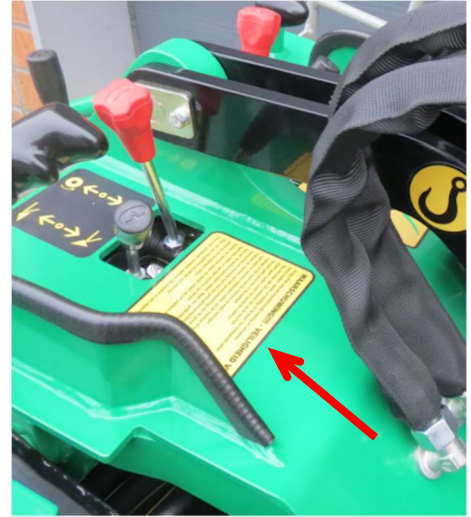

(*Test safety label)

WARNING!!! SAFETY FIRST!!!

Wear tight and protecting clothing and shoes
Keep hands, feet and clothing away from moving parts
Only drive the machine with one person standing on the machine
Don't place your feet below the standing platform
Do not carry people in the bucket
Never park or drive with the machine on steep hillsides
Never leave the machine unattended, turn the machine off and remove the ignition key
Park your machine with the attachment on the ground
Don't exceed the maximum load (see user manual)
Don't pull the steering levers. Please make a smooth fluid motion
Drive calm when driving on rough terrain
Only operate the machine when your feet are placed on the platform and your hands are tightly placed around the handles
Do not leave the platform with the loading lifted
Ensure adequate ventilation when the machine is used in confined spaces



Danger!

Venting hose

Always make sure that the venting hose is free from dust and dirt. When the battery is being charged in a confined space an extension tube must be coupled which is conducted to an open and/or adequately ventilated area. Make sure the venting hose has no obstructions in any way!

3.4.2. Traction battery

The following pictograms are placed on the traction battery. These pictograms warn the user for potential risks or hazards arising from the use of the traction battery. The pictograms may not be removed. If the icons are damaged or have become illegible they should be replaced.

Pictogram	Explanation
	<i>Danger from battery</i>
	<i>Risk of caustic substances</i>
	<i>Explosion hazard</i>
	<i>Smoking/open flames are prohibited</i>
	<i>Read the user manual before use</i>
	<i>Always wear safety goggles</i>
	<i>Always wear protective clothing</i>
	<i>Traction batteries can be reused and recycled</i>

Place on the traction battery



4. Operation

4.1. Control elements

There are four spring-loaded levers at the front of the mini skid-steer.

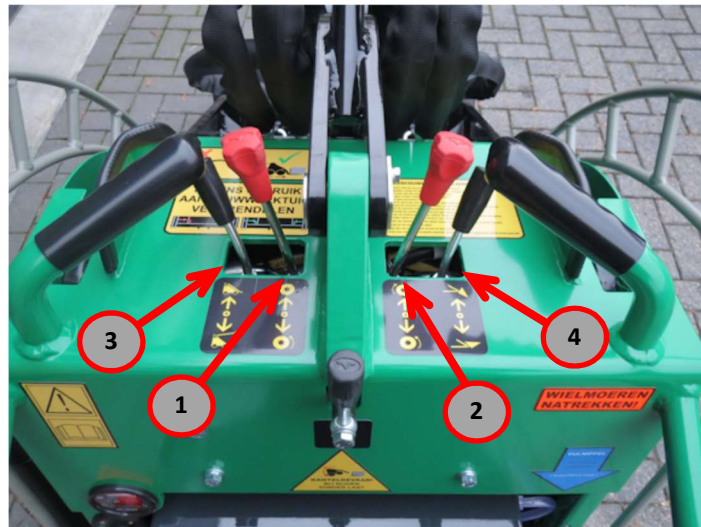

4.1.1. Drive controls

The left red lever (1) operates the wheels on the left side and the right red lever (2) operates the wheels on the right side of the mini skid-steer.

Operate drive controls calmly and cautiously; a very small motion can have a very big effect. All lever actions must be carried out steadily and smoothly.

To drive the mini skid-steer forwards, push both levers forward with the same force and to drive backwards, push both levers backward with the same force.

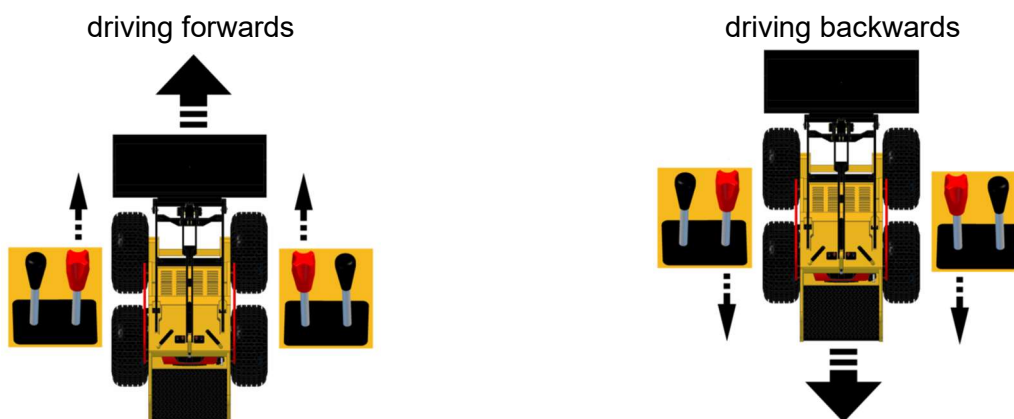

The mini skid-steer is steered by pushing or pulling one lever further forward or backward than the other.

To turn the machine to the left while driving:
forwards: Push the right lever further forward than the left lever.

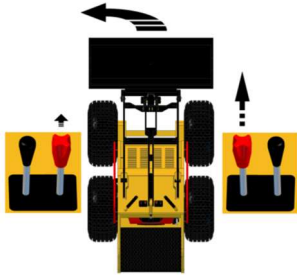

To turn the machine to the right while driving:
forwards: Push the left lever further forward than the right lever.

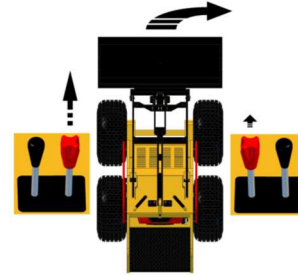

To turn the machine to the left while driving:
backwards: Pull the right lever further backwards than the left lever.

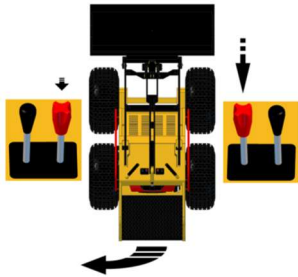

To turn the machine to the right while driving
backwards: Pull the left lever further backward than the right lever.

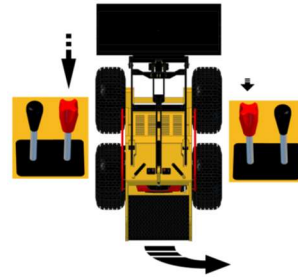

To turn the mini skid-steer on its axis (skidding), push one lever forward and pull the other backward.

turn counterclockwise

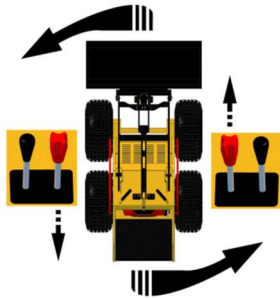

turn clockwise

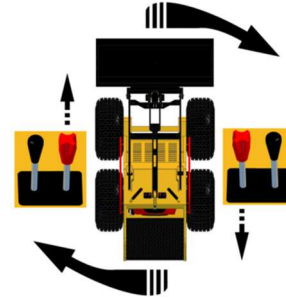

Attention!

If you have good surface traction, it will be virtually impossible to turn the mini skid-steer on its own axis.



Attention!

Do not use any of the levers until both your feet are firmly planted on the platform and you are tightly holding both levers.

4.1.2. Braking

Bring driving levers slowly to center position.



Attention!

Be careful when you stop. The machine can topple over if a bucket or other attachment tool is still raised. Drive slowly and make steady and flowing motions when driving with raised lift arms. All new operators must first work with the machine in an open space until they master the steering and driving.



Danger!

Parking position

When idle, always lower the attachment tools to the ground (do not stop the machine on a slope!). This prevents the vehicle from setting itself in motion unexpectedly.

4.1.3. Lifting control

The outermost control lever on the left side (3) operates the lifting function.

Pushing the lever forward lowers the lifting arm and pulling the lever backward raises the lifting arm. The lever is spring-loaded and will return to its neutral position when released.



4.1.4. Tilting control

The outermost control lever on the right side (4) operates the tilting function of attachment tools such as buckets, pallet forks, etc. Pushing the lever forward tilts the bucket downward and pulling the lever backward straightens the bucket and raises it. The lever is spring-loaded and will return to its neutral position when released.



4.1.5. Auxiliary lever

The auxiliary lever operates the hydraulic drive system for the attachment tools.



The lever has three positions:

- Center position: hydraulic drive system for the tools is inactive
- Downward position: oil flows to the left coupling
- Upward position: oil flows to the right coupling

The lever is not spring loaded and must be returned to its neutral position manually.



Attention!

Because the direction of rotation or motion depends on the tool that is attached, the direction of the oil flow is indicated.



Attention!

Make sure the auxiliary lever is in the neutral position when not in use. This prevents power being lost. The engine is difficult to start when the lever is not in the neutral position. The hydraulic oil can overheat.

4.2. Operating the engine

4.2.1. Starting the engine

Insert the plug (1) into the socket on the left backside of the machine. Insert the key (2) in the mass switch and turn it clockwise. The battery level indicator (3) lights up and shows the remaining capacity of the battery.

Move behind the platform and operate the motor switch with both feet (4). The electro engine starts to run. Now it is possible to drive the machine or to use it as a power pack.



Take into account a starting delay of the electric engine of two seconds.



The engine may not be started before you are sure that the mini-loader will not move. Make sure that when you start the mini-loader no one stands in the vicinity of the mini-loader.

4.2.2. Stopping the engine

Park the mini skid-steer on a level surface. Never park on a slope. The bucket and/or attachment tools must always be lowered to the ground.

Step off the platform so that the electric engine switches off. Turn off the mass switch to the OFF-position. Make sure the control levers are placed in neutral position and remove the key from the ignition.

4.3. Loading and unloading

Follow the below instructions when loading and unloading:



Stability

Take the condition of the terrain into account (holes, uneven, swampy). When driving with a raised load, the speed must be as low as possible to minimize the risk of toppling over. You must lift and lower material and drive the mini skid-steer as steadily as possible to guarantee the machine remains stable.



Driving with load

Always drive with the load's center of gravity as close to the ground as possible. This reduces the risk of toppling over. When driving up or down a hill with a load, you must drive backwards or forwards, depending on the load (see below figure).

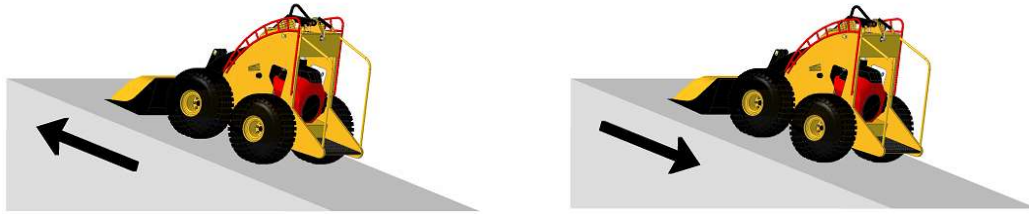

(driving with load)

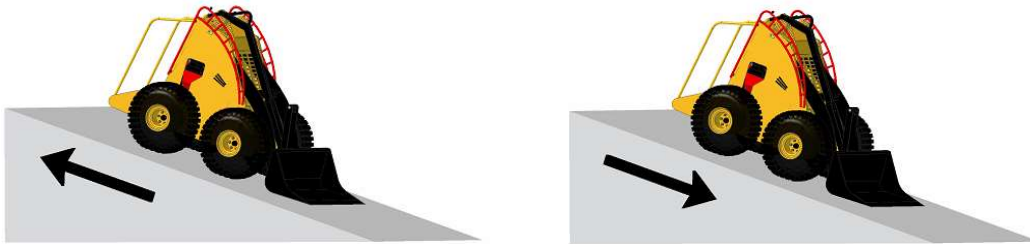

(driving without load)



Danger!

Capacity

Observe the allowable machine capacity indicated in section 1.2.2. (Tipping loads). Overloading the machine can have serious implications, such as the machine toppling over.



Danger!

Ending work, taking a break

The attachment tools must be lowered to the ground when the mini skid-steer is not in use (do not park on a slope).

Remove the key from the ignition when you leave the mini skid-steer.



Danger!

Bystanders

Bystanders are not allowed to linger around the mini skid-steer.



Danger!

Stability

When driving on hilly terrain or slopes, you must pay attention to the angle of incline and always drive with the load's center of gravity as close to the ground as possible. A sharp angle of incline affects the machine's stability.

4.4. Attaching and detaching attachment tools

4.4.1. Requirements for attachment tools



Attachment tools

Only attachment tools with a CE-mark may be mounted on the mini skid-steer. It is prohibited to use attachment tools with an allowed mechanical and/or hydraulic load or capacity that is higher than that of the mini skid-steer.



Type of suspension

The mini skid-steer is equipped with a mounting plate with two fastening points. Only use attachment tools that are designed for this type of fastening.

4.4.2. Mounting plate



Foto: SHERPA100Smal

The mini skid-steer comes with a mounting plate only. The mounting plate makes it easy to attach and detach tools and implements.

The right and left side of the mounting plate is equipped with a fixing pin that is locked by a safety pin.

4.4.3. Attaching tools

Starting with an empty mounting plate, proceed as follows:

- In the lift arms' lowest position, place the mounting plate at a 45 degree forward angle.
- Drive the mini skid-steer straight towards the tool.
- Place the mounting plate against the tool and position the fixing strips on the tool in the notch on the mounting plate.
- Raise the mounting plate by extending the lifting cylinders ("lift") while moving the mounting plate backward ("dip"). This slides the tool into the notches.
- Push the two fixing pins through the fixing strips past the safety pin.



Foto: SHERPA100Smal



Foto: SHERPA100Smal

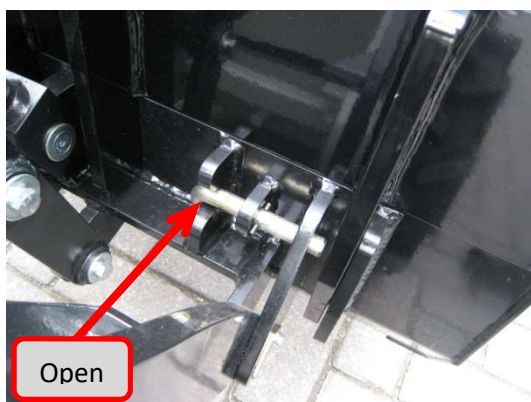

Check

Always check that the tool is fastened properly. A tool that is not properly fastened can cause serious damage!

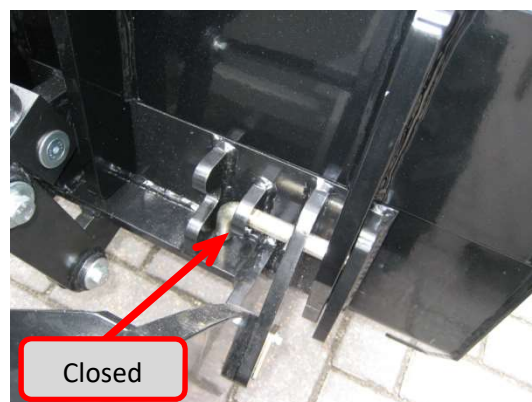
4.4.4. Detaching tools

To detach a tool, proceed as follows:

- Slide the two lock pins in the “open” position.
- Lower the mounting plate by retracting (“lowering”) the lifting cylinders.
- Allow the tool to the ground in conjunction with “tipping”. The tool will now slide out of the notches on the mounting plate.
- Drive slowly backwards.

Always make sure the attachment tools are properly locked before using the machine!!!

4.4.5. Auxiliary system



The mini skid-steer is equipped with hydraulic quick-couplings (see arrow) on the lift system. These quick-couplings enable you to connect tools such as rotating brooms and other hydraulic attachment tools.

The quick-couplings are equipped with check valves that ensure that the hydraulic oil does not squirt out when you change tools.



Before attaching and detaching a tool, always make sure the coupling is clean and free of sand and dirt. A small amount of oil is released when the quick-coupling is removed. Use a clean cloth to clean up any spilt oil.

5. Use of the traction battery

5.1. General



Attention!

Always load the traction battery and then refill the electrolyte (battery).



Danger!

Before performing maintenance work (filling, charging, etc.), always switch off the engine, remove the key from the grounding switch and disconnect the traction battery.



Attention!

When working with traction batteries, Standard DIN VDE 0510 Part 3 'Traction batteries for electrical vehicles' applies.



Attention!

In order to achieve maximum battery life, the battery may not be used to more than 80% of its nominal capacity.



Attention!

Low batteries must be charged quickly to prevent damage to the cells. This also applies to batteries that are only partly charged.

5.2. Charging Traction battery



*The battery may only be charged with direct current.
All of the charging systems that meet Standard DIN 41773 and 41774 can be used.
Connect the battery only to the matching charger with the correct setting to prevent overcharging it, sharp temperature increases, excessive gas formation and the overflow of electrolytes.*

5.2.1. Installing the charger

The charger may not be installed near reflector heaters. The openings in the cabinet are heat vents and may not be covered. Place the charger in a dry room with sufficient ventilation. Observe Standard DIN VDE 510, Part 1. The charger must be protected against humidity, may only be used in dry rooms and only by specially trained staff. Remove the power plug from the power socket before removing the battery from its housing.

5.2.2. Connection sequence



The instructions for explosion-proof batteries [Ex1 and Ex2] must be followed closely to ensure they do not explode.



Danger of explosion

Oxyhydrogen, a highly explosive gas mixture, is released during and immediately following charging. The cells must not, under any circumstance, come anywhere near naked flames or glowing parts, and metal objects may not be placed on the battery. To prevent sparks, live power cables may not be connected or disconnected while charging.

- Disconnect the plug for the traction battery from the machine.
- Connect the plug for the traction battery to the connector (1) on the charger.
- Connect the power plug (2) for the charger to a power socket.
- Make sure the ventilation hose (3) is free of obstruction and can dispose of any gases that are released.
- Switch on the charger to automatically start charging the battery.





When connecting the charger to the power supply (230 V/400 V AC), the power socket must be protected with a suitable slow blow fuse or K type fuse. All chargers come with a transformer with nominal voltage U_0 / U (230 V/400 V) and have connections for +6%/-6%, -10%. When the battery is put into operation, it is imperative that the voltage on the transformer and the mains are the same.



See the user guide of the charger for a description of the charging process.

When the charging process has been completed, **first** remove the charger from the mains and then disconnect the charging cable.

5.2.3. Lithium Battery Operation

- o To turn on depress ¼" round button. Button should light up blue if on
- o Unit has 12 hour timer for shutoff if it is not in use
- o If the button is depressed but is not on, depress button to release it, then depress again to turn the unit on. Button should light up blue if the unit is on.
- o Unit must be on in order to accept a charge.

5.2.4. Lithium Battery Charging

- o To turn on depress ¼" round button. Button should light up blue if on
- o Unit has 12 hour timer for shutoff if it is not in use
- o If the button is depressed but is not on, depress button to release it, then depress again to turn the unit on. Button should light up blue if the unit is on.
- o Unit must be on in order to accept a charge.

5.2.5. Lithium Battery Temperature Controls

- o Storage between 10°C and 55°C (50°F and 131°F)
- o Charging between 0°C and 45°C (32°F and 113°F)
- o Operation between -10°C and 55°C (14°F and 131°F)

5.2.5. Lithium Battery Dangers

- o See MSDS in Operations Manual

5.3. Refilling

The electrolyte level must be checked after charging. If necessary, top up with distilled water.

The traction battery is equipped with an automatic filling system.

A central filling system quickly fills all of the cells at the same time. The filling system is time-saving because a float ensures that each cell is automatically filled to the correct level.

The flow of liquid is controlled by a flow indicator.

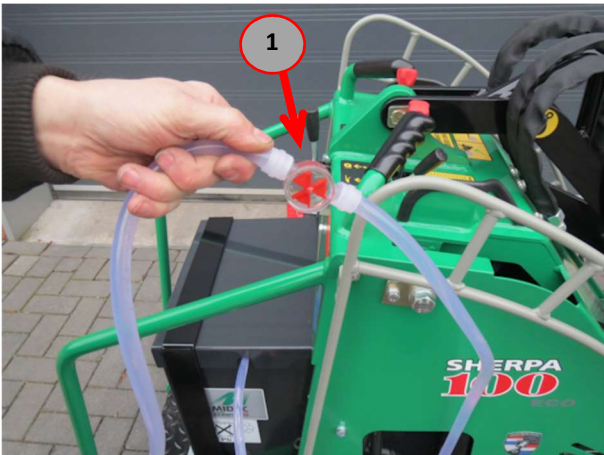

5.3.1. Installation mini-loader



Place the mini-skid loader in a sufficiently ventilated area.

Place the mini skid steer on a level and solid surface and make sure the traction battery is level.

Place the tank (1) at a height of two meters from the top of the traction battery.

Connect filling tank

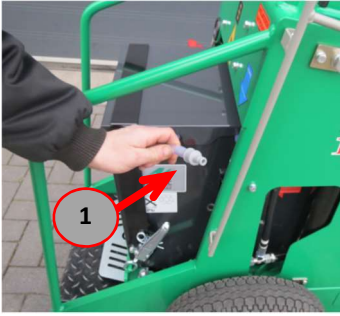

The filling hose (1) is located at the traction battery on the right side of the mini-loader



Connect the hose on the refill vat to the connection on the traction battery (2)



Open the filling tap (3) on the refill vat.

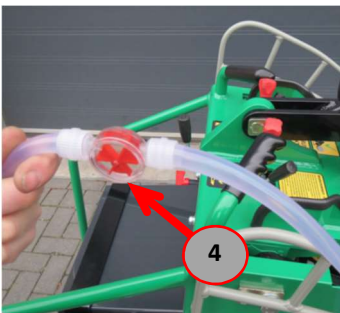

Allow the refill tank until the flow indicator (4) stops running.

Detach the refill vat.

Close the filling tap on the refill vat.

Disconnect the hose from the machine.

5.4. Changing Traction battery

The mini-skid loader is equipped with a quick change system for the traction battery.

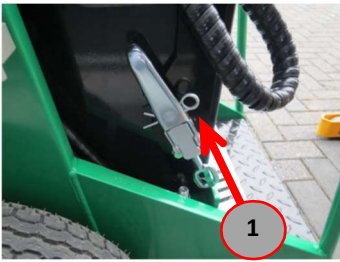

Remove the hairpin springs (1) from the latches.



Fold down the the latches (2) so that the bracket comes loose from the machine.

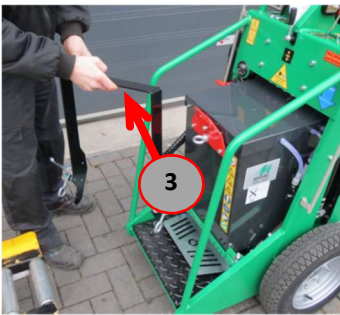

Remove the bracket (3).



Fold down the battery bracket (4).

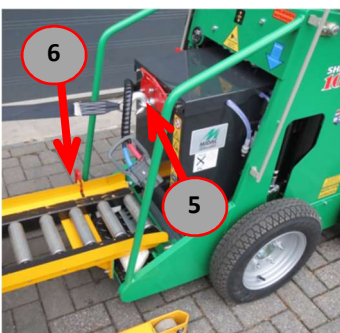

Pull the traction battery from the machine (5).

There is an option "quick change system (6)" available to exchange.

Slide another traction battery into the machine and secure the battery in reverse order.

(*available as an option)

Battery change truck and storage refill station.



6. Maintenance

6.1. General

The mini skid-steer must be maintained periodically, i.e. the machine and the parts cleaned, hinging parts lubricated, the oil changed and so forth. Maintaining the machine as recommended prevents failures and extends the mini skid-steer's service life.



General safety rules for maintenance

Work on the mini skid-steer may only be carried out by trained staff.

Before working on the mini skid-steer, make sure it is standing on a level and solid surface.

Work may only be carried out with the engine switched off and a disconnected traction battery. Work on the hydraulic drive system may only be carried out when the system is not under pressure.



Environment

Environmentally harmful substances (e.g. liquids and lubricants) must be stored and disposed of in accordance with the applicable regulations.

6.1.1. Locking the lift arm



When carrying out maintenance and/or repair work on the mini skid-steer with the lift arm raised, the lift arm must be locked in place with the supplied tools. **Always** remove the attachment tools first.

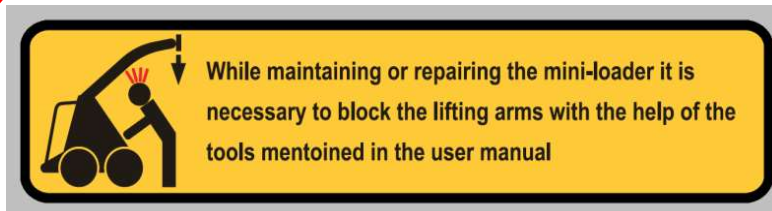

Raise the lift arm to the highest position.

Place the tool between the cylinder sleeve and the spherical rod eye.

Lower the lift arm slowly until the tool wedges into place.



Make sure you do not get trapped between any moving parts when attaching tools.



Lock the lift arm during maintenance/repair to prevent trapping.

6.1.2. Hour counter & battery level indicator



The hour counter and battery level indicator (1) are located on top of the control panel. On the small screen you can see the total working hours of the machine. The battery level indicator points out how many hours can be worked with the machine. When the voltage of the battery gets below the minimum, a buzzer will be activated. After this buzzer it is necessary to charge the traction battery immediately.



Attention!

Don't discharge the nominal battery capacity for more than 80%. In this way you can maximally profit and extend the life cycle of the battery.



Attention!

To prevent damage to the cells discharged batteries must be recharged as soon as possible. This applies also to batteries, which are only partially loaded

6.2. Maintenance schedule for traction batteries

Task	See sector.	Daily	Half-yearly	Yearly
Charging	6.3.1	✓	✓	✓
Refilling distilled water	6.3.2	✓	✓	✓
Check specific gravity and temperature	6.4.1		✓	✓
Check isolation resistance	6.5.1			✓



Attention!

Environment

Environmentally harmful substances (e.g. liquids and lubricants) must be stored and disposed of in accordance with the applicable regulations.



Attention!

Before servicing the traction battery carefully read the user manual of the traction battery.

6.3. Daily

6.3.1. Charging



Attention!

The Battery should be recharged after every discharge. See section 5.2. (Charging).

6.3.2. Refilling distilled water



Attention!

The electrolyte level should be checked after every recharge of the battery. If necessary, top up with distilled water. Battery recharge after a discharge. See section 5.3. (Refilling).

6.4. Half-yearly

6.4.1. Check specific gravity and temperature



Attention!

From all cells (when the charger is switched on) the tension, specific gravity, and the temperature of the electrolyte must be measured and written down. Please note these data at the beginning and at the end of the recharging process. A battery check sheet is provided for these data.



Attention!

The battery should be tested by the supplier if large changes are measured in these values or when the cells show major differences mutually.

6.5. Yearly

6.5.1. Check isolation resistance



Attention!

According to the VDE 0117 norm the isolation resistance of the battery and/or machine must be checked at least once a year by an expert. This expert will measure the battery according to the DIN 43539/1 norm.

The measured insulation resistance of the battery should, according to the Standard DIN VDE 0510/3 norm, not be lower than 50ohm per volt nominal battery voltage. This means that a 24Volt battery has a minimum value of 1200Ohm.

6.6. Maintenance schedule for the mini skid-steer

Task	See section	10 operating hours (daily)	50 operating hours (monthly)	200 operating hours (half-yearly)	600 operating hours (yearly)	1000 operating hours
Check for leaks in the hydraulic drive systems	6.7.2	✓	✓	✓	✓	✓
Check the hydraulic oil level	6.7.3	✓	✓	✓	✓	✓
Check control elements		✓	✓	✓	✓	✓
Check wheel nuts	6.8.2	After first 8 hours	✓	✓	✓	✓
Check tire pressure	6.8.3		✓	✓	✓	✓
Check that drive motors are securely fastened			✓	✓	✓	✓
Change the hydraulic oil filter	6.9.2		1 st 50-100 hours	✓	✓	✓
Check/adjust chain tension	6.9.4		1 st 50-100 hours	✓	✓	✓
Check/replace pins and bearing bushes	6.9.5			✓	✓	✓
Check all fasteners	6.9.3				✓	✓
Check system pressure					✓	✓
Change hydraulic oil	6.11.1					✓



Attention!

Maintenance by a certified dealer

Following are the schedules for the maintenance that needs to be carried out after the first 10, 50, 200, 600 and 1000 hours of operation. These maintenance schedules must be carried out by a certified dealer or the guarantee will lapse.

6.7. Every 10 operating hours or daily

6.7.1. General



Danger!

General safety rules for maintenance

Work on the mini skid-steer may only be carried out by trained staff.

Before working on the mini skid-steer, make sure it is standing on a level and solid surface. Work may only be carried out with the engine switched off.



Attention!

Environment

Environmentally harmful substances (e.g. liquids and lubricants) must be stored and disposed of in accordance with the applicable regulations.

6.7.2. Check for leaks in the hydraulic drive systems



Danger!

Hydraulic hoses and other parts must be replaced if wear and tear or damage is detected during periodic maintenance.



Danger!

Work may only be carried out with the engine switched off and a disconnected traction battery. Work on the hydraulic drive system may only be carried out when the system is not under pressure. All hydraulic cylinders must be in their rest position.



Danger!

- *Never try to repair or seal hydraulic hoses or couplings while the machine is running or when the hydraulic drive system is under pressure. The liquid has such a high pressure that the hydraulic oil can easily penetrate the skin and cause serious injuries.*
- *Wait until the hydraulic oil has cooled down. Hot hydraulic oil can cause serious burns.*
- *Never use your hands to check the hydraulic drive system for leaks. Hydraulic oil can cause serious injury if it penetrates the human body.*
- *Always wear safety gloves and the appropriate eye protection when working on the hydraulic drive system.*

Check the whole machine daily for leaks in the hydraulic drive systems. Check the material, hoses, couplings etc. for wear and tear.

6.7.3. Check the hydraulic oil level



The oil level is checked with a dipstick (1) that is at the front of the machine on the hydraulic tank. The level must reach the notch (2) on the dipstick. All of the cylinders must be retracted when checking the oil level. Oil must be added if the level is too low!



Fix leaks immediately; oil is harmful to the environment and soils roads.

Top up the oil reservoir if a lot of oil is lost. Pass the oil through a filter to filter out as many impurities as possible (a hydraulic drive system's biggest enemy is impurities: dirt particles, metal particles, etc.).



*The hydraulic drive system should only be opened in a **clean environment!***

6.8. Every 50 operating hours or monthly

6.8.1. General



Danger!

General safety rules for maintenance

Work on the mini skid-steer may only be carried out by trained staff.

Before working on the mini skid-steer, make sure it is standing on a level and solid surface. Work may only be carried out with the engine switched off.



Attention!

Environment

Environmentally harmful substances (e.g. liquids and lubricants) must be stored and disposed of in accordance with the applicable regulations.

6.8.2. Check wheel nuts



Attention!

Check the wheel nuts daily for the first 50 operating hours and tighten if necessary.

The prescribed torque is 80Nm. Check the wheel nuts by tightening them until you reach the correct torque.

6.8.3. Check tire pressure



Attention!

The correct pressure for the standard tires is (type 4.00 x 10) 2.5 bar.



Attention!

Check the tire pressure daily for the first 50 operating hours. The instructions are provided below.

6.8.3.2. Check

If the pressure is low, increase the pressure to the level indicated above.

Remove the protection cap from the valve.

- Remove the valve cover.
- Place the tire pressure gauge on the valve and check the pressure (see photo).
- Increase the pressure if the pressure is too low (see above).
- Replace the protection cap on the valve.



Photo: SHERPA100small

6.8.3.2. Other types of tires



Attention!

If you are not using the standard tires, the tire pressure may be different. Ask your tire dealer for the corresponding pressure levels and operating conditions.

The surface also plays a role. A hard surface requires a high tire pressure because the tires would wear too quickly otherwise. If the machine is used in a field, the tire pressure must be lower in order to increase the traction.

6.9. Every 200 operating hours or half-yearly

6.9.1. General



Danger!

General safety rules for maintenance

Work on the mini skid-steer may only be carried out by trained staff.

Before working on the mini skid-steer, make sure it is standing on a level and solid surface. Work may only be carried out with the engine switched off and a disconnected traction battery.



Attention!

Environment

Environmentally harmful substances (e.g. liquids and lubricants) must be stored and disposed of in accordance with the applicable regulations.

6.9.2. Change the hydraulic oil filter



Danger!

Work may only be carried out with the engine switched off and a disconnected traction battery. Work on the hydraulic drive system may only be carried out when the system is not under pressure. All hydraulic cylinders must be in their rest position.



Danger!

Hazards working on hydraulic drive systems

- *Never try to repair or seal hydraulic hoses or couplings while the machine is running or when the hydraulic drive system is under pressure. The liquid has such a high pressure that the hydraulic oil can easily penetrate the skin and cause serious injuries.*
- *Wait until the hydraulic oil has cooled down. Hot hydraulic oil can cause serious burns.*
- *Never use your hands to check the hydraulic drive system for leaks. Hydraulic oil can cause serious injury if it penetrates the human body.*
- *Always wear safety gloves and the appropriate eye protection when working on the hydraulic drive system.*

- Make sure the new filter is clean. Keep the filter in the packaging for as long as possible.
- Unscrew the cap from the filter unit.
- Remove the old filter.
- You must collect the oil that runs out and dispose of it at a recycling depot.
- Lubricate the rubber gasket with oil before inserting the new filter.
- Insert the new filter unit.
- Screw the cap tightly onto the filter unit.

6.9.3. Check all fasteners

Check all bolts, nuts and other fasteners. Tighten them if necessary. Replace damaged fasteners immediately.

6.9.4. Check/adjust chain tension



Before working on the mini skid-steer, make sure it is standing on a level and solid surface. Work may only be carried out with the engine switched off and a disconnected traction battery.

Check the chain tension through the inspection hole in the chain guard between the wheels.

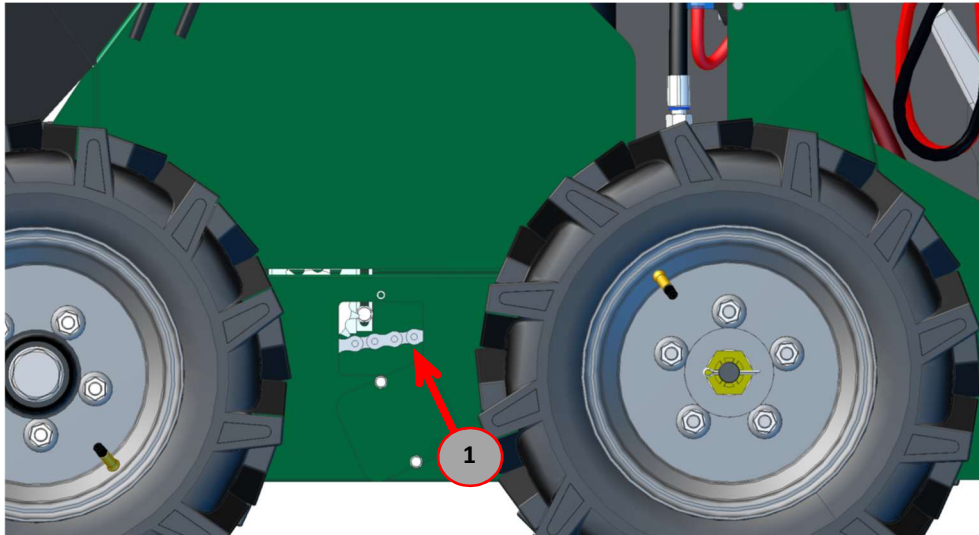

You must remove the wheels and the chain guard to adjust the chain tension. Use a rack to place the chain adjuster in the right position. Loosen the four M8 bolts and adjust the chain to the correct tension. Fasten the four bolts and replace the chain guard and the wheels.

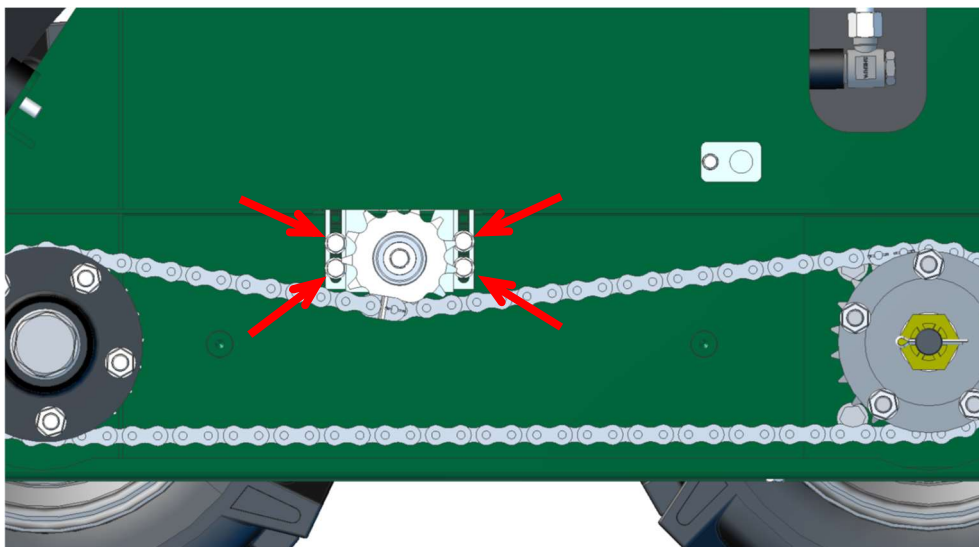

6.9.5. Check/replace pins and bearing bushes



Before working on the mini skid-steer, make sure it is standing on a level and solid surface. Work may only be carried out with the engine switched off and a disconnected traction battery.

The hinge points on the mini skid-steer are equipped with pins and high-quality plastic bushes. These parts are sensitive to wear from sand, dust and dirt. Check regularly for slack between the hinge points and replace the pins and bearing bushes in time to prevent damaging the machine.

6.10. Every 600 operating hours or yearly

6.10.1. Change the wheels

When mounting a wheel, fasten the wheel nuts a few turns. Then tighten the nuts in a criss-cross pattern until you reach the correct torque.

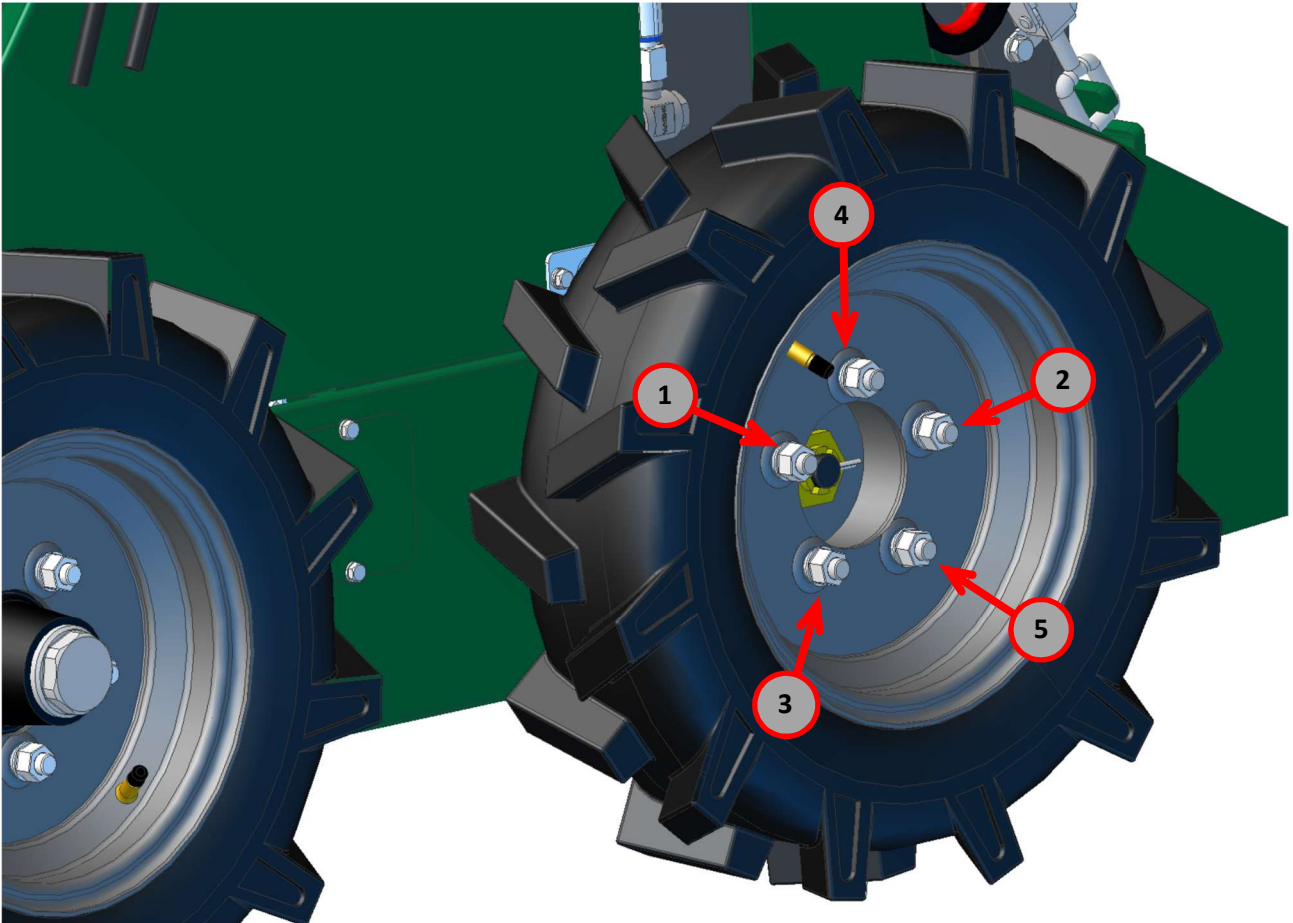

6.11. Every 1000 operating hours

6.11.1. Change hydraulic oil



Attention!

The hydraulic drive system should only be opened in a **clean environment!**



Danger!

Work may only be carried out with the engine switched off and a disconnected traction battery. Work on the hydraulic drive system may only be carried out when the system is not under pressure. All hydraulic cylinders must be in their rest position.



Danger!

- Wait until the hydraulic oil has cooled down. Hot hydraulic oil can cause serious burns.
- Always wear safety gloves and the appropriate eye protection when working on the hydraulic drive system.

- You need a collection tank that can store at least 50 litres.
- Loosen the drain screw and the mouth of the hydraulic fluid reservoir. You must collect the old oil and dispose of it at a recycling depot.
- Replace the sealing ring and close the drain plug tightly so it doesn't leak.
- Add new hydraulic oil through the mouth of the reservoir. Fill the reservoir up to the notch on the dipstick.
- Close the mouth (make sure no impurities get in the tank).



Attention!

Use only Mobil Univis N32 or an equivalent product.

7. Transport and storage

7.1. Transport

7.1.1. Transportation on a trailer

The mini-loader must be driven backwards on a trailer due to the risk of tipping over.



Danger!

The driver should be aware of the risk of tipping over when no attachments are mounted on the machine.



Attention!

First come to a stop before switching from backward driving to forward driving.

7.1.2. Towing



Attention!

*The mini skid-steer may **not** be towed.*

7.1.3. Lifting



Attention!

The machine's weight is 759kg, without attachment tools.



Danger!

Only use material with sufficient hoist and lifting capacity. Only use material that is sufficiently strong and of good quality.



Danger!

Never stand under the load you are hoisting or lifting!

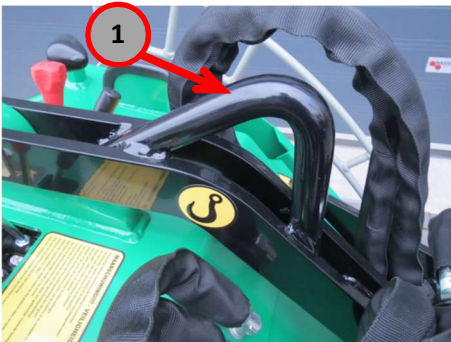

The mini skid-steer may be lifted only at the following point (indicated by the sticker):



Attention!

When securing the machine (e.g. on a trailer) with cables and bungee cords you must use the above attachment point.

7.2. Storage

7.2.1. Preparing the machine for storage



Attention!

Storage temperature

The storage temperature must be between -20°C and +30°C. Storage outside these temperatures can damage the machine.

Proceed as follows if the machine will be stored for a longer period:

- Clean the whole machine thoroughly.
- Change the engine oil and run the engine for 5 minutes so the oil spreads to all of the parts.
- Check all bolts and nuts, and tighten them to the correct torque if necessary.
- Make sure the battery is charged. If necessary, connect it to a trickle charger.
- Run the engine in idle every 2 to 3 months for about 5 minutes to prevent corrosion.
- Lubricate all naked parts.
- Check the hydraulic oil level and add oil if necessary.
- Put the machine on blocks to raise the tires from the ground.
- Let some air out of the tires.
- Remove the ignition key to prevent unauthorized use of the vehicle.

7.2.2. Preparing the machine for use

Proceed as follows to prepare the machine for use:

- Check the hydraulic oil level and add oil if necessary.
- Inflate the tires to the correct pressure.
- Remove the blocks under the wheels.
- Start the engine.
- Go through the checklist.

8. Driving on hilly terrain and slopes

When driving on hilly terrain or slopes, you must pay attention to the angle of incline and always drive with the load's center of gravity as close to the ground as possible. A sharp angle of incline affects the machine's stability.



Danger!

Remember that the machine can lose stability on hilly terrain and slopes.

9. Failures

9.1. Melting fuse table

<i>Function</i>	<i>Value (Amp)</i>	<i>Place</i>
<i>Main fuse</i>	160	Inside left panel
<i>Fuse buzzer</i>	4	Inside left panel



Danger!

Before you replace the fuse ***first*** eliminate the cause of the malfunction.

10. Appendices

10.1. Hydraulics diagram

Hydraulics diagrams are provided on request.

10.2. Electrical circuit diagrams

Electrical circuit diagrams are provided on request.

10.3. User manual charger

See the user manual of IEB which is also supplied.

10.4. Operation & maintenance instructions for traction batteries

See the instructions of "Batterij Aandrijf Techniek B.V which is also supplied.

10.5. Attachment tools & accessories

See enclosed Annex.

10.6. EG declaration & checklist

See enclosed Annex.